

Actuators

Careful design and high quality manufacture throughout ensure long service life and optimum economy.
 Mounting dimensions fully in accordance with ISO 6432 and CETOP RP52P greatly simplifies installation and world-wide interchangeability.



- Conforms to ISO 6432
- Available in 10 to 25 mm bores
- Corrosion resistant design and low weight construction
- Magnetic piston as standard
- End stroke buffers for long service life

Operating information

Working pressure: Max 10 bar
 Temperature range: -20°C to +80°C Ø10-25mm

Prelubricated, further lubrication is not normally necessary.
 If additional lubrication is introduced it must be continued.

Double acting buffer cushioning

Ø10mm - (M5)

Stroke mm	Order code
10	P1A-S010DS-0010
25	P1A-S010DS-0025
50	P1A-S010DS-0050
80	P1A-S010DS-0080

Ø12mm - (M5)

Stroke mm	Order code
10	P1A-S012DS-0010
25	P1A-S012DS-0025
50	P1A-S012DS-0050
80	P1A-S012DS-0080

Ø16mm - (M5)

Stroke mm	Order code
10	P1A-S016DS-0010
25	P1A-S016DS-0025
50	P1A-S016DS-0050
80	P1A-S016DS-0080

Ø20mm - (G1/8)

Stroke mm	Order code
10	P1A-S020DS-0010
25	P1A-S020DS-0025
50	P1A-S020DS-0050
80	P1A-S020DS-0080
100	P1A-S020DS-0100
125	P1A-S020DS-0125
160	P1A-S020DS-0160

Ø25mm - (G1/8)

Stroke mm	Order code
10	P1A-S025DS-0010
25	P1A-S025DS-0025
50	P1A-S025DS-0050
80	P1A-S025DS-0080
100	P1A-S025DS-0100
125	P1A-S025DS-0125
160	P1A-S025DS-0160

Cylinders are supplied complete with neck mounting and piston rod nuts.
 Cylinders with Through piston rods are supplied with two piston rod nuts and one neck mounting nut.

Single acting push type (Spring return for retract stroke)

Ø10mm - (M5)

Stroke mm	Order code
10	P1A-S010SS-0010
25	P1A-S010SS-0025

Ø12mm - (M5)

Stroke mm	Order code
25	P1A-S012SS-0025
50	P1A-S012SS-0050

Ø16mm - (M5)

Stroke mm	Order code
25	P1A-S016SS-0025
50	P1A-S016SS-0050

Ø20mm - (G1/8)

Stroke mm	Order code
25	P1A-S020SS-0025
50	P1A-S020SS-0050

Ø25mm - (G1/8)

Stroke mm	Order code
25	P1A-S025SS-0025
50	P1A-S025SS-0050

Double acting adjustable cushioning

Ø16mm - (M5)

Stroke mm	Order code
25	P1A-S016MS-0025
50	P1A-S016MS-0050
100	P1A-S016MS-0100

Ø20mm - (G1/8)

Stroke mm	Order code
25	P1A-S020MS-0025
50	P1A-S020MS-0050
100	P1A-S020MS-0100

Ø25mm - (G1/8)

Stroke mm	Order code
25	P1A-S025MS-0025
50	P1A-S025MS-0050
100	P1A-S025MS-0100

P1A Cylinder Mounting Options

Flange MF8

	Cyl. bore Ø mm	Order code
	10	P1A-4CMB
	12	P1A-4DMB
	16	P1A-4DMB
	20	P1A-4HMB
	25	P1A-4HMB

Foot MS3

	Cyl. bore Ø mm	Order code
	10	P1A-4CMF
	12	P1A-4DMF
	16	P1A-4DMF
	20	P1A-4HMF
	25	P1A-4HMF

Swivel rod eye AP6

	Cyl. bore Ø mm	Order code
	10	P1A-4CRS
	12	P1A-4DRS
	16	P1A-4DRS
	20	P1A-4HRS
	25	P1A-4JRS

Clevis bracket AB3

	Cyl. bore Ø mm	Order code
	10	P1A-4CMT
	12	P1A-4DMT
	16	P1A-4DMT
	20	P1A-4HMT
	25	P1A-4HMT

Clevis AP2

	Cyl. bore Ø mm	Order code
	10	P1A-4CRC
	12	P1A-4DRC
	16	P1A-4DRC
	20	P1A-4HRC
	25	P1A-4JRC

Sensors

Output/function	Cable/connector	Order code
Electronic sensors , 10-30 V DC		
PNP type, normally open	0,27 m PUR-cable and 8 mm snap-in male connector	P8S-GPSHX
PNP type, normally open	0,27 m PUR-cable and M12 screw male connector	P8S-GPMHX
PNP type, normally open	3 m PVC-cable without connector	P8S-GPFLX
PNP type, normally open	10 m PVC-cable without connector	P8S-GPFTX
Reed sensors , 10-30 V AC/DC		
Normally open	0,27 m PUR-cable and 8 mm snap-in male connector	P8S-GSSHX
Normally open	0,27 m PUR-cable and M12 screw male connector	P8S-GSMHX
Normally open	3 m PVC-cable without connector	P8S-GSFLX
Normally open	10 m PVC-cable without connector	P8S-GSFTX
Normally closed	5m PVC-cable without connector ⁽¹⁾	P8S-GCFPX
Reed sensors, 10-120 V AC/DC		
Normally open	3 m PVC-cable without connector	P8S-GRFLX
Reed sensorer, 24-230 V AC/DC		
Normally open	3 m PVC-cable without connector	P8S-GRFLX2

Sensor mounting

Description	Weight kg	Order code
Sensor mounting for P1A cylinder bore Ø10 to Ø25 mm	0,07	P8S-TMC01

Connecting cables with one connector

The cables have an integral snap-in female connector.



Cables for sensors, complete with one female connector

Cable/connector	Order code
3 m, 8 mm Snap-in connector	9126344341
10 m, 8 mm Snap-in connector	9126344342

1) Without LED

Double acting with stainless steel piston rod

- Conforms to ISO 15552.
- Bore 32-125 mm.
- Double acting.
- Stainless steel piston rod.
- Robust design.
- Adjustable air cushioning.
- Retained stainless steel cushioning screws.
- Wide range of mountings and drop-in sensors



Operating information

Working pressure: Max 10 bar
 Standard Temperature: -20°C to +80°C

For more information see www.parker.com/euro_pneumatic

Double acting pneumatic cushioning

Cyl. bore mm	Stroke	Order code
32 Conn. G1/8	25	P1D-B032MS-0025
	40	P1D-B032MS-0040
	50	P1D-B032MS-0050
	80	P1D-B032MS-0080
	100	P1D-B032MS-0100
	125	P1D-B032MS-0125
	160	P1D-B032MS-0160
	200	P1D-B032MS-0200
	250	P1D-B032MS-0250
	320	P1D-B032MS-0320
	400	P1D-B032MS-0400
500	P1D-B032MS-0500	
40 Conn. G1/4	25	P1D-B040MS-0025
	40	P1D-B040MS-0040
	50	P1D-B040MS-0050
	80	P1D-B040MS-0080
	100	P1D-B040MS-0100
	125	P1D-B040MS-0125
	160	P1D-B040MS-0160
	200	P1D-B040MS-0200
	250	P1D-B040MS-0250
	320	P1D-B040MS-0320
	400	P1D-B040MS-0400
500	P1D-B040MS-0500	
50 Conn. G1/4	25	P1D-B050MS-0025
	40	P1D-B050MS-0040
	50	P1D-B050MS-0050
	80	P1D-B050MS-0080
	100	P1D-B050MS-0100
	125	P1D-B050MS-0125
	160	P1D-B050MS-0160
	200	P1D-B050MS-0200
	250	P1D-B050MS-0250
	320	P1D-B050MS-0320
	400	P1D-B050MS-0400
500	P1D-B050MS-0500	
63 Conn. G3/8	25	P1D-B063MS-0025
	40	P1D-B063MS-0040
	50	P1D-B063MS-0050
	80	P1D-B063MS-0080
	100	P1D-B063MS-0100
	125	P1D-B063MS-0125
	160	P1D-B063MS-0160
	200	P1D-B063MS-0200
	250	P1D-B063MS-0250
	320	P1D-B063MS-0320
	400	P1D-B063MS-0400
500	P1D-B063MS-0500	

Cyl. bore mm	Stroke	Order code
80 Conn. G3/8	25	P1D-B080MS-0025
	40	P1D-B080MS-0040
	50	P1D-B080MS-0050
	80	P1D-B080MS-0080
	100	P1D-B080MS-0100
	125	P1D-B080MS-0125
	160	P1D-B080MS-0160
	200	P1D-B080MS-0200
	250	P1D-B080MS-0250
	320	P1D-B080MS-0320
	400	P1D-B080MS-0400
500	P1D-B080MS-0500	
100 Conn. G1/2	25	P1D-B100MS-0025
	40	P1D-B100MS-0040
	50	P1D-B100MS-0050
	80	P1D-B100MS-0080
	100	P1D-B100MS-0100
	125	P1D-B100MS-0125
	160	P1D-B100MS-0160
	200	P1D-B100MS-0200
	250	P1D-B100MS-0250
	320	P1D-B100MS-0320
	400	P1D-B100MS-0400
500	P1D-B100MS-0500	
125 Conn. G1/2	25	P1D-B125MS-0025
	40	P1D-B125MS-0040
	50	P1D-B125MS-0050
	80	P1D-B125MS-0080
	100	P1D-B125MS-0100
	125	P1D-B125MS-0125
	160	P1D-B125MS-0160
	200	P1D-B125MS-0200
	250	P1D-B125MS-0250
	320	P1D-B125MS-0320
	400	P1D-B125MS-0400
500	P1D-B125MS-0500	

Flange MF1 / MF2

Cyl. bore Ø mm	Order code
32	P1C-4KMB
40	P1C-4LMB
50	P1C-4MMB
63	P1C-4NMB
80	P1C-4PMB
100	P1C-4QMB
125	P1C-4RMB

Foot brackets MS1

Cyl. bore Ø mm	Order code
32	P1C-4KMF
40	P1C-4LMF
50	P1C-4MMF
63	P1C-4NMF
80	P1C-4PMF
100	P1C-4QMF
125	P1C-4RMF

Pivot bracket with rigid bearing AB7

Cyl. bore Ø mm	Order code
32	P1C-4KMDB
40	P1C-4LMDB
50	P1C-4MMDB
63	P1C-4NMDB
80	P1C-4PMDB
100	P1C-4QMDB
125	P1C-4RMDB

Swivel eye bracket MP6

Cyl. bore Ø mm	Order code
32	PD23843
40	PD23844
50	PD23845
63	PD23846
80	PD23847
100	PD23848
125	PD23849

Clevis bracket MP2

Cyl. bore Ø mm	Order code
32	P1C-4KMTB
40	P1C-4LMTB
50	P1C-4MMTB
63	P1C-4NMTB
80	P1C-4PMTB
100	P1C-4QMTB
125	P1C-4RMTB

Clevis bracket MP4

Cyl. bore Ø mm	Order code
32	PD23412
40	PD23413
50	PD23414
63	PD23415
80	PD23416
100	PD23417
125	PD23418

Clevis bracket AB6

Cyl. bore Ø mm	Order code
32	P1C-4KMCB
40	P1C-4LMCB
50	P1C-4MMCB
63	P1C-4NMCB
80	P1C-4PMCB
100	P1C-4QMCB
125	P1C-4RMCB

Pivot bracket with swivel bearing CS7

Cyl. bore Ø mm	Order code
32	KC5130
40	KC5131
50	KC5132
63	KC5133
80	KC5134
100	KC5135
125	KC5136

3 & 4 positions glange JP1

Cyl. bore Ø mm	Order code
32	P1E-6KB0
40	P1E-6LB0
50	P1E-6MB0
63	P1E-6NB0
80	P1E-6PB0
100	P1E-6QB0

Pivot brackets AT4 for trunnion MT*

Cyl. bore Ø mm	Order code
32	PD23381
40	PD23382
50	PD23382
63	PD23383
80	PD23383
100	PD23384
125	PD23384

Swivel rod eye AP6

Cyl. bore Ø mm	Order code
32	P1C-4KRS
40	P1C-4LRS
50	P1C-4MRS
63	P1C-4MRS
80	P1C-4PRS
100	P1C-4PRS
125	P1C-4RRS

Clevis AP2

Cyl. bore Ø mm	Order code
32	P1C-4KRC
40	P1C-4LRC
50	P1C-4MRC
63	P1C-4MRC
80	P1C-4PRC
100	P1C-4PRC
125	P1C-4RRC

Flexo coupling PM5

Cyl. bore Ø mm	Order code
32	KY1129
40	KY1131
50	KY1133
63	KY1133
80	KY1134
100	KY1134
125	KC5036

Nut MR9 *

Cyl. bore Ø mm	Order code
32	P14-4KRPZ
40	P14-4LRPZ
50	P14-4MRPZ
63	P14-4MRPZ
80	P14-4PRPZ
100	P14-4PRPZ
125	P14-4RRPZ

* Supplied as pack of 10 off

Sensors

Output/function	Cable/connector	Order code
Electronic sensors , 10-30 V DC		
PNP type, normally open	0,27 m PUR-cable and 8 mm snap-in male connector	P8S-GPSHX
PNP type, normally open	0,27 m PUR-cable and M12 screw male connector	P8S-GPMHX
PNP type, normally open	3 m PVC-cable without connector	P8S-GPFLX
PNP type, normally open	10 m PVC-cable without connector	P8S-GPFTX
Reed sensors , 10-30 V AC/DC		
Normally open	0,27 m PUR-cable and 8 mm snap-in male connector	P8S-GSSHX
Normally open	0,27 m PUR-cable and M12 screw male connector	P8S-GSMHX
Normally open	3 m PVC-cable without connector	P8S-GSFLX
Normally open	10 m PVC-cable without connector	P8S-GSFTX
Normally closed	5m PVC-cable without connector ⁽¹⁾	P8S-GCFPX
Reed sensors, 10-120 V AC/DC		
Normally open	3 m PVC-cable without connector	P8S-GRFLX
Reed sensor, 24-230 V AC/DC		
Normally open	3 m PVC-cable without connector	P8S-GRFLX2

Connecting cables with one connector

The cables have an integral snap-in female connector.



Cables for sensors, complete with one female connector

Cable/connector	Order code
3 m, 8 mm Snap-in connector	9126344341
10 m, 8 mm Snap-in connector	9126344342

1) Without LED

P1D-S series. This series is the ultimate in ISO pneumatic cylinders and is suitable for virtually any application. Options include the tie rod design, smooth profile, ultra clean cylinders for use in the food industry and all the variants illustrated on page 33 including through rod and piston rod locking versions.



- Available in 32 to 125 mm bores
- PUR seals for long service life
- Drop-in sensors
- Corrosion resistant design
- Magnetic piston as standard
- Lubricated with food grade grease

Operating information

Working pressure:	Max 10 bar
Seals / Temperature options	
Standard:	-20°C to +80°C
High temperature:	-10°C to +150°C
Low temperature:	-40°C to +80°C
Cylinders for low pressure hydraulic operation:	Ø32-125mm
ATEX approval:	CE Ex IIGD c T4 120°C

For ATEX specific products contact Sales Office

Double acting pneumatic cushioning

Ø32mm - (G^{1/8})

Stroke mm	Order code
25	P1D-S032MS-0025
40	P1D-S032MS-0040
50	P1D-S032MS-0050
80	P1D-S032MS-0080
100	P1D-S032MS-0100
125	P1D-S032MS-0125
160	P1D-S032MS-0160
200	P1D-S032MS-0200
250	P1D-S032MS-0250
320	P1D-S032MS-0320
400	P1D-S032MS-0400
500	P1D-S032MS-0500

Ø40mm - (G^{1/4})

Stroke mm	Order code
25	P1D-S040MS-0025
40	P1D-S040MS-0040
50	P1D-S040MS-0050
80	P1D-S040MS-0080
100	P1D-S040MS-0100
125	P1D-S040MS-0125
160	P1D-S040MS-0160
200	P1D-S040MS-0200
250	P1D-S040MS-0250
320	P1D-S040MS-0320
400	P1D-S040MS-0400
500	P1D-S040MS-0500

Ø50mm - (G^{1/4})

Stroke mm	Order code
25	P1D-S050MS-0025
40	P1D-S050MS-0040
50	P1D-S050MS-0050
80	P1D-S050MS-0080
100	P1D-S050MS-0100
125	P1D-S050MS-0125
160	P1D-S050MS-0160
200	P1D-S050MS-0200
250	P1D-S050MS-0250
320	P1D-S050MS-0320
400	P1D-S050MS-0400
500	P1D-S050MS-0500

Ø63mm - (G^{3/8})

Stroke mm	Order code
25	P1D-S063MS-0025
40	P1D-S063MS-0040
50	P1D-S063MS-0050
80	P1D-S063MS-0080
100	P1D-S063MS-0100
125	P1D-S063MS-0125
160	P1D-S063MS-0160
200	P1D-S063MS-0200
250	P1D-S063MS-0250
320	P1D-S063MS-0320
400	P1D-S063MS-0400
500	P1D-S063MS-0500

Ø80mm - (G^{3/8})

Stroke mm	Order code
25	P1D-S080MS-0025
40	P1D-S080MS-0040
50	P1D-S080MS-0050
80	P1D-S080MS-0080
100	P1D-S080MS-0100
125	P1D-S080MS-0125
160	P1D-S080MS-0160
200	P1D-S080MS-0200
250	P1D-S080MS-0250
320	P1D-S080MS-0320
400	P1D-S080MS-0400
500	P1D-S080MS-0500

Ø100mm - (G^{1/2})

Stroke mm	Order code
25	P1D-S100MS-0025
40	P1D-S100MS-0040
50	P1D-S100MS-0050
80	P1D-S100MS-0080
100	P1D-S100MS-0100
125	P1D-S100MS-0125
160	P1D-S100MS-0160
200	P1D-S100MS-0200
250	P1D-S100MS-0250
320	P1D-S100MS-0320
400	P1D-S100MS-0400
500	P1D-S100MS-0500

Ø125mm - (G^{1/2})

Stroke mm	Order code
25	P1D-S125MS-0025
40	P1D-S125MS-0040
50	P1D-S125MS-0050
80	P1D-S125MS-0080
100	P1D-S125MS-0100
125	P1D-S125MS-0125
160	P1D-S125MS-0160
200	P1D-S125MS-0200
250	P1D-S125MS-0250
320	P1D-S125MS-0320
400	P1D-S125MS-0400
500	P1D-S125MS-0500

The cylinders are supplied complete with a zinc plated steel piston rod nut.

Flange MF1 / MF2

	Cyl. bore Ø mm	Order code
	32	P1C-4KMB
	40	P1C-4LMB
	50	P1C-4MMB
	63	P1C-4NMB
	80	P1C-4PMB
	100	P1C-4QMB
	125	P1C-4RMB

Clevis bracket MP4

	Cyl. bore Ø mm	Order code
	32	P1C-4KME
	40	P1C-4LME
	50	P1C-4MME
	63	P1C-4NME
	80	P1C-4PME
	100	P1C-4QME
	125	P1C-4RME

Swivel rod eye AP6

	Cyl. bore Ø mm	Order code
	32	P1C-4KRS
	40	P1C-4LRS
	50	P1C-4MRS
	63	P1C-4MRS
	80	P1C-4PRS
	100	P1C-4PRS
	125	P1C-4RRS

Foot brackets MS1

	Cyl. bore Ø mm	Order code
	32	P1C-4KMF
	40	P1C-4LMF
	50	P1C-4MMF
	63	P1C-4NMF
	80	P1C-4PMF
	100	P1C-4QMF
	125	P1C-4RMF

Clevis bracket AB6

	Cyl. bore Ø mm	Order code
	32	P1C-4KMCA
	40	P1C-4LMCA
	50	P1C-4MMCA
	63	P1C-4NMCA
	80	P1C-4PMCA
	100	P1C-4QMCA
	125	P1C-4RMCA

Clevis AP2

	Cyl. bore Ø mm	Order code
	32	P1C-4KRC
	40	P1C-4LRC
	50	P1C-4MRC
	63	P1C-4MRC
	80	P1C-4PRC
	100	P1C-4PRC
	125	P1C-4RRC

Pivotbracket with rigid bearing AB7

	Cyl. bore Ø mm	Order code
	32	P1C-4KMD
	40	P1C-4LMD
	50	P1C-4MMD
	63	P1C-4NMD
	80	P1C-4PMD
	100	P1C-4QMD
	125	P1C-4RMD

Pivotbracket with swivel bearing CS7

	Cyl. bore Ø mm	Order code
	32	P1C-4KMA
	40	P1C-4LMA
	50	P1C-4MMA
	63	P1C-4NMA
	80	P1C-4PMA
	100	P1C-4QMA
	125	P1C-4RMA

Flexo coupling PM5

	Cyl. bore Ø mm	Order code
	32	P1C-4KRF
	40	P1C-4LRF
	50	P1C-4MRF
	63	P1C-4MRF
	80	P1C-4PRF
	100	P1C-4PRF
	125	P1C-4RRF

Swivel eye bracket MP6

	Cyl. bore Ø mm	Order code
	32	P1C-4KMSA
	40	P1C-4LMSA
	50	P1C-4MMSA
	63	P1C-4NMSA
	80	P1C-4PMSA
	100	P1C-4QMSA
	125	P1C-4RMSA

3 & 4 positions flange JP1

	Cyl. bore Ø mm	Order code
	32	P1E-6KB0
	40	P1E-6LB0
	50	P1E-6MB0
	63	P1E-6NB0
	80	P1E-6PB0
	100	P1E-6QB0

Nut MR9 *

	Cyl. bore Ø mm	Order code
	32	P14-4KRPZ
	40	P14-4LRPZ
	50	P14-4MRPZ
	63	P14-4MRPZ
	80	P14-4PRPZ
	100	P14-4PRPZ
	125	P14-4RRPZ

Clevis bracket MP2

	Cyl. bore Ø mm	Order code
	32	P1C-4KMT
	40	P1C-4LMT
	50	P1C-4MMT
	63	P1C-4NMT
	80	P1C-4PMT
	100	P1C-4QMT
	125	P1C-4RMT

Pivot brackets AT4 for trunnion MT*

	Cyl. bore Ø mm	Order code
	32	9301054261
	40	9301054262
	50	9301054262
	63	9301054264
	80	9301054264
	100	9301054266
	125	9301054266

Stainless steel nut MR9 *

	Cyl. bore Ø mm	Order code
	32	P14-4KRPS
	40	P14-4LRPS
	50	P14-4MRPS
	63	P14-4MRPS
	80	P14-4PRPS
	100	P14-4PRPS
	125	P14-4RRPS

* Supplied as pack of 10 off

Sensors

Output/function	Cable/connector	Order code
Electronic sensors , 10-30 V DC		
PNP type, normally open	0,27 m PUR-cable and 8 mm snap-in male connector	P8S-GPSHX
PNP type, normally open	0,27 m PUR-cable and M12 screw male connector	P8S-GPMHX
PNP type, normally open	3 m PVC-cable without connector	P8S-GPFLX
PNP type, normally open	10 m PVC-cable without connector	P8S-GPFTX
Reed sensors , 10-30 V AC/DC		
Normally open	0,27 m PUR-cable and 8 mm snap-in male connector	P8S-GSSHX
Normally open	0,27 m PUR-cable and M12 screw male connector	P8S-GSMHX
Normally open	3 m PVC-cable without connector	P8S-GSFLX
Normally open	10 m PVC-cable without connector	P8S-GSFTX
Normally closed	5m PVC-cable without connector ⁽¹⁾	P8S-GCFPX
Reed sensors, 10-120 V AC/DC		
Normally open	3 m PVC-cable without connector	P8S-GRFLX
Reed sensor, 24-230 V AC/DC		
Normally open	3 m PVC-cable without connector	P8S-GRFLX2

Connecting cables with one connector

The cables have an integral snap-in female connector.



Cables for sensors, complete with one female connector

Cable/connector	Order code
3 m, 8 mm Snap-in connector	9126344341
10 m, 8 mm Snap-in connector	9126344342

1) Without LED

The P1D-T range of cylinders is intended for use in a wide range of applications. Careful design and high quality manufacture throughout ensure long service life and optimum economy. Mounting dimensions fully in accordance with ISO 15552 (ISO 6431 and CETOP RP52P) greatly simplifies installation and world-wide interchangeability.



- Bore sizes Ø160 - Ø320mm
- Stroke lengths 10mm - 2000mm
- Magnetic piston as standard
- Adjustable cushioning as standard
- High temperature versions
- ATEX version
- Special version on request

Operating information

Working pressure:	Max 10 bar
Seals / Temperature options	
Standard:	-20°C to +80°C
High temperature:	-10°C to +150°C
ATEX approval:	CE Ex IIGD c T4 120°C

Double acting pneumatic cushioning

Ø160mm		Ø200mm		Ø250mm	
Stroke mm	Order code	Stroke mm	Order code	Stroke mm	Order code
50	P1D-T160MS-0050	50	P1D-T200MS-0050	50	P1D-T250MS-0050
80	P1D-T160MS-0080	80	P1D-T200MS-0080	80	P1D-T250MS-0080
100	P1D-T160MS-0100	100	P1D-T200MS-0100	100	P1D-T250MS-0100
125	P1D-T160MS-0125	125	P1D-T200MS-0125	125	P1D-T250MS-0125
160	P1D-T160MS-0160	160	P1D-T200MS-0160	160	P1D-T250MS-0160
200	P1D-T160MS-0200	200	P1D-T200MS-0200	200	P1D-T250MS-0200
250	P1D-T160MS-0250	250	P1D-T200MS-0250	250	P1D-T250MS-0250
320	P1D-T160MS-0320	320	P1D-T200MS-0320	320	P1D-T250MS-0320
400	P1D-T160MS-0400	400	P1D-T200MS-0400	400	P1D-T250MS-0400
500	P1D-T160MS-0500	500	P1D-T200MS-0500	500	P1D-T250MS-0500
800	P1D-T160MS-0800	800	P1D-T200MS-0800	800	P1D-T250MS-0800
1000	P1D-T160MS-1000	1000	P1D-T200MS-1000	1000	P1D-T250MS-1000

Ø320mm	
Stroke mm	Order code
50	P1D-T320MS-0050
80	P1D-T320MS-0080
100	P1D-T320MS-0100
125	P1D-T320MS-0125
160	P1D-T320MS-0160
200	P1D-T320MS-0200
250	P1D-T320MS-0250
320	P1D-T320MS-0320
400	P1D-T320MS-0400
500	P1D-T320MS-0500
800	P1D-T320MS-0800
1000	P1D-T320MS-1000

The cylinders are supplied complete with a zinc plated steel piston rod nut.

Flange MF1 / MF2

Cyl. bore Ø mm	Order code
160	PD23410
200	PD24924
250	PD25761
320	KL9140



Clevis bracket MP2

Cyl. bore Ø mm	Order code
160	P1C-4SMTB
200	P1C-4TMTB
250	P1C-4UMTB
320	P1C-4VMTB



Swivel rod eye AP6

Cyl. bore Ø mm	Order code
160	KY6863
200	KY6863
250	KY6864
320	KL9132



Foot brackets MS1

Cyl. bore Ø mm	Order code
160	PD22027
200	PD24792
250	PD25758
320	KL9139



Clevis bracket MP4

Cyl. bore Ø mm	Order code
160	PD22628
200	PD24999
250	PD25759
320	KL9135



Clevis AP2

Cyl. bore Ø mm	Order code
160	KY6867
200	KY6867
250	KY6868
320	KL9131



Pivot bracket with rigid bearing AB7

Cyl. bore Ø mm	Order code
160	P1C-4SMDB
200	P1C-4TMDDB
250	P1C-4UMDC
320	P1C-4VMDC



Pivot brackets AT4 for trunnion MT*

Cyl. bore Ø mm	Order code
160	PD24425
200	PD24425
250	PD25763
320	KL9130



Flexo coupling PM5

Cyl. bore Ø mm	Order code
160	KY1139
200	KY1139
250	KY1140
320	KL9133



Swivel eye bracket MP6

Cyl. bore Ø mm	Order code
160	PD23850
200	PD25766
250	PD25760
320	KL9136



Centre trunnion MT4

Cyl. bore Ø mm	Order code
160	-
200	-
250	-
320	-



Sensors

Output/function	Cable/connector	Order code
Electronic sensors , 10-30 V DC		
PNP type, normally open	0,27 m PUR-cable and 8 mm snap-in male connector	P8S-GPSHX
PNP type, normally open	0,27 m PUR-cable and M12 screw male connector	P8S-GPMHX
PNP type, normally open	3 m PVC-cable without connector	P8S-GPFLX
PNP type, normally open	10 m PVC-cable without connector	P8S-GPFTX
Reed sensors , 10-30 V AC/DC		
Normally open	0,27 m PUR-cable and 8 mm snap-in male connector	P8S-GSSHX
Normally open	0,27 m PUR-cable and M12 screw male connector	P8S-GSMHX
Normally open	3 m PVC-cable without connector	P8S-GSFLX
Normally open	10 m PVC-cable without connector	P8S-GSFTX
Normally closed	5m PVC-cable without connector ⁽¹⁾	P8S-GCFPX
Reed sensors, 10-120 V AC/DC		
Normally open	3 m PVC-cable without connector	P8S-GRFLX
Reed sensorer, 24-230 V AC/DC		
Normally open	3 m PVC-cable without connector	P8S-GRFLX2

Sensor mounting

Description	Weight kg	Order code
Sensor mounting for P1D-T cylinder bore Ø160 to Ø320 mm	0,040	PD48956

Connecting cables with one connector

The cables have an integral snap-in female connector.



Cables for sensors, complete with one female connector

Cable/connector	Order code
3 m, 8 mm Snap-in connector	9126344341
10 m, 8 mm Snap-in connector	9126344342

1) Without LED

Double acting - Female threaded piston rod

The versatile range of Short Build Cylinders. Integral sensor grooves, suitable for a wide range of applications.



- Bore 20-100 mm with ISO 21287 conformity
- Double acting with female piston rod thread
- Ideal for applications where space is at a premium
- Corrosion resistant thanks to use of anodised aluminium and stainless steel
- Elastic cushioning facilitates high speeds and short cycle times.
- Flexible direct mounting with through holes and threads
- Wide range of mountings and drop-in sensors

Operating information

Working pressure: Max 10 bar
 Permissible fluid: Air, with or without lubrication
 Seals / Temperature options
 Standard: -20°C to +80°C
 High temperature: -10°C to +120°C
 Low temperature: -40°C to +80°C
 Prelubricated, further lubrication is not normally necessary. If additional lubrication is introduced it must be continued.

Double acting - Female threaded piston rod

Ø20mm - (M5)

Stroke mm	Order code
5	P1PS020DS7G0005
10	P1PS020DS7G0010
15	P1PS020DS7G0015
20	P1PS020DS7G0020
25	P1PS020DS7G0025
30	P1PS020DS7G0030
40	P1PS020DS7G0040
50	P1PS020DS7G0050
60	P1PS020DS7G0060

Ø25mm - (M5)

Stroke mm	Order code
5	P1PS025DS7G0005
10	P1PS025DS7G0010
15	P1PS025DS7G0015
20	P1PS025DS7G0020
25	P1PS025DS7G0025
30	P1PS025DS7G0030
40	P1PS025DS7G0040
50	P1PS025DS7G0050
60	P1PS025DS7G0060

Ø32mm - (G1/8)

Stroke mm	Order code
5	P1PS032DS7G0005
10	P1PS032DS7G0010
15	P1PS032DS7G0015
20	P1PS032DS7G0020
25	P1PS032DS7G0025
30	P1PS032DS7G0030
40	P1PS032DS7G0040
50	P1PS032DS7G0050
60	P1PS032DS7G0060
80	P1PS032DS7G0080

Ø40mm - (G1/8)

Stroke mm	Order code
5	P1PS040DS7G0005
10	P1PS040DS7G0010
15	P1PS040DS7G0015
20	P1PS040DS7G0020
25	P1PS040DS7G0025
30	P1PS040DS7G0030
40	P1PS040DS7G0040
50	P1PS040DS7G0050
60	P1PS040DS7G0060
80	P1PS040DS7G0080

Ø50mm - (G1/8)

Stroke mm	Order code
5	P1PS050DS7G0005
10	P1PS050DS7G0010
15	P1PS050DS7G0015
20	P1PS050DS7G0020
25	P1PS050DS7G0025
30	P1PS050DS7G0030
40	P1PS050DS7G0040
50	P1PS050DS7G0050
60	P1PS050DS7G0060
80	P1PS050DS7G0080

Ø63mm - (G1/8)

Stroke mm	Order code
5	P1PS063DS7G0005
10	P1PS063DS7G0010
15	P1PS063DS7G0015
20	P1PS063DS7G0020
25	P1PS063DS7G0025
30	P1PS063DS7G0030
40	P1PS063DS7G0040
50	P1PS063DS7G0050
60	P1PS063DS7G0060
80	P1PS063DS7G0080

Ø80mm - (G1/8)

Stroke mm	Order code
5	P1PS080DS7G0005
10	P1PS080DS7G0010
15	P1PS080DS7G0015
20	P1PS080DS7G0020
25	P1PS080DS7G0025
30	P1PS080DS7G0030
40	P1PS080DS7G0040
50	P1PS080DS7G0050
60	P1PS080DS7G0060
80	P1PS080DS7G0080
100	P1PS080DS7G0100

Ø100mm - (G1/8)

Stroke mm	Order code
10	P1PS100DS7G0010
15	P1PS100DS7G0015
20	P1PS100DS7G0020
25	P1PS100DS7G0025
30	P1PS100DS7G0030
40	P1PS100DS7G0040
50	P1PS100DS7G0050
60	P1PS100DS7G0060
80	P1PS100DS7G0080
100	P1PS100DS7G0100

Double acting - Guided

This cylinder version feature twin guide rods connected to the piston rod by a large flange plate. These cylinders are ideal for clamping an moving applications where turning of the piston rod must be avoided.



- Bore 20-100 mm
- Double acting with non rotating linear movement
- For fixing, clamping and moving anti rotate applications
- Anodised end covers, tool plate and barrel
- Stainless steel guide rods and piston rod as standard
- Flexible direct mounting with through holes and threads
- Wide range of mountings and drop-in sensors

Double acting - Guided**Ø20mm - (M5)**

Stroke mm	Order code
5	P1PG020DS7G0005
10	P1PG020DS7G0010
15	P1PG020DS7G0015
20	P1PG020DS7G0020
25	P1PG020DS7G0025
30	P1PG020DS7G0030
40	P1PG020DS7G0040
50	P1PG020DS7G0050
60	P1PG020DS7G0060

Ø25mm - (M5)

Stroke mm	Order code
5	P1PG025DS7G0005
10	P1PG025DS7G0010
15	P1PG025DS7G0015
20	P1PG025DS7G0020
25	P1PG025DS7G0025
30	P1PG025DS7G0030
40	P1PG025DS7G0040
50	P1PG025DS7G0050
60	P1PG025DS7G0060

Ø32mm - (G1/8)

Stroke mm	Order code
5	P1PG032DS7G0005
10	P1PG032DS7G0010
15	P1PG032DS7G0015
20	P1PG032DS7G0020
25	P1PG032DS7G0025
30	P1PG032DS7G0030
40	P1PG032DS7G0040
50	P1PG032DS7G0050
60	P1PG032DS7G0060
80	P1PG032DS7G0080

Ø40mm - (G1/8)

Stroke mm	Order code
5	P1PG040DS7G0005
10	P1PG040DS7G0010
15	P1PG040DS7G0015
20	P1PG040DS7G0020
25	P1PG040DS7G0025
30	P1PG040DS7G0030
40	P1PG040DS7G0040
50	P1PG040DS7G0050
60	P1PG040DS7G0060
80	P1PG040DS7G0080

Ø50mm - (G1/8)

Stroke mm	Order code
5	P1PG050DS7G0005
10	P1PG050DS7G0010
15	P1PG050DS7G0015
20	P1PG050DS7G0020
25	P1PG050DS7G0025
30	P1PG050DS7G0030
40	P1PG050DS7G0040
50	P1PG050DS7G0050
60	P1PG050DS7G0060
80	P1PG050DS7G0080

Ø63mm - (G1/8)

Stroke mm	Order code
5	P1PG063DS7G0005
10	P1PG063DS7G0010
15	P1PG063DS7G0015
20	P1PG063DS7G0020
25	P1PG063DS7G0025
30	P1PG063DS7G0030
40	P1PG063DS7G0040
50	P1PG063DS7G0050
60	P1PG063DS7G0060
80	P1PG063DS7G0080

Ø80mm - (G1/8)

Stroke mm	Order code
5	P1PG080DS7G0005
10	P1PG080DS7G0010
15	P1PG080DS7G0015
20	P1PG080DS7G0020
25	P1PG080DS7G0025
30	P1PG080DS7G0030
40	P1PG080DS7G0040
50	P1PG080DS7G0050
60	P1PG080DS7G0060
80	P1PG080DS7G0080
100	P1PG080DS7G0100

Ø100mm - (G1/8)

Stroke mm	Order code
10	P1PG100DS7G0010
15	P1PG100DS7G0015
20	P1PG100DS7G0020
25	P1PG100DS7G0025
30	P1PG100DS7G0030
40	P1PG100DS7G0040
50	P1PG100DS7G0050
60	P1PG100DS7G0060
80	P1PG100DS7G0080
100	P1PG100DS7G0100

	Flange MF1 / MF2 ¹	Foot brackets MS1 ²	Pivot bracket with rigid bearing AB7 ³	Clevis bracket MP2 ⁴	Clevis bracket MP4 ⁵
Ø 20	P1P-4HMB	P1P-4HMF			P1P-4HME
Ø 25	P1P-4JMB	P1P-4JMF			P1P-4JME
Ø 32	P1C-4KMB	P1C-4KMF	P1C-4KMD	P1C-4KMT	P1C-4KME
Ø 40	P1C-4LMB	P1C-4LMF	P1C-4LMD	P1C-4LMT	P1C-4LME
Ø 50	P1C-4MMB	P1C-4MMF	P1C-4MMD	P1C-4MMT	P1C-4MME
Ø 63	P1C-4NMB	P1C-4NMF	P1C-4NMD	P1C-4NMT	P1C-4NME
Ø 80	P1C-4PMB	P1C-4PMF	P1C-4PMD	P1C-4PMT	P1C-4PME
Ø 100	P1C-4QMB	P1C-4QMF	P1C-4QMD	P1C-4QMT	P1C-4QME
	Clevis bracket AB6 ⁶	Pivot bracket with swivel bearing CS7 ⁷	Swivel eye ⁸ bracket MP6	3 and 4 positions flange JP1	Swivel rod eye AP6 ¹⁰
Ø 20					P1A-4HRS
Ø 25					P1A-4HRS
Ø 32	P1C-4KMCA	P1C-4KMA	P1C-4KMSA	P1E-6KB0	P1C-4KRS
Ø 40	P1C-4LMCA	P1C-4LMA	P1C-4LMSA	P1E-6LB0	P1C-4KRS
Ø 50	P1C-4MMCA	P1C-4MMA	P1C-4MMSA	P1E-6MB0	P1C-4LRS
Ø 63	P1C-4NMCA	P1C-4NMA	P1C-4NMSA	P1E-6NB0	P1C-4LRS
Ø 80	P1C-4PMCA	P1C-4PMA	P1C-4PMSA	P1E-6PB0	P1C-4MRS
Ø 100	P1C-4QMCA	P1C-4QMA	P1C-4QMSA	P1E-6QB0	P1C-4MRS
	Clevis AP2 ¹¹	Flexo coupling PM5 ¹²	Nut MR9 (Pack of 10 off)	Stainless Steel Nut MR9 (Pack of 10 off)	
Ø 20	P1A-4HRC	P1C-4HRF	P14-4HRPZ	P14-4HRPS	
Ø 25	P1A-4HRC	P1C-4HRF	P14-4HRPZ	P14-4HRPS	
Ø 32	P1C-4KRC	P1C-4KRF	P14-4KRPZ	P14-4KRPS	
Ø 40	P1C-4KRC	P1C-4KRF	P14-4KRPZ	P14-4KRPS	
Ø 50	P1C-4LRC	P1C-4LRF	P14-4LRPZ	P14-4LRPS	
Ø 63	P1C-4LRC	P1C-4LRF	P14-4LRPZ	P14-4LRPS	
Ø 80	P1C-4MRC	P1C-4MRF	P14-4MRPZ	P14-4MRPS	
Ø 100	P1C-4MRC	P1C-4MRF	P14-4MRPZ	P14-4MRPS	

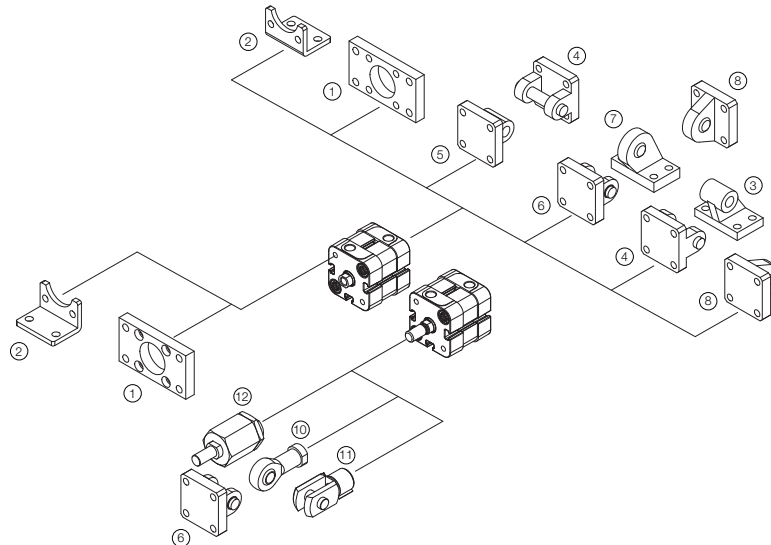

Ordering data

Output/function	Cable/connector	Weight kg	Order code
Electronic sensors , 10-30 V DC			
PNP type, normally open	0,27 m PUR-cable and 8 mm snap-in male connector	0,007	P8S-GPSHX
PNP type, normally open	0,27 m PUR-cable and M12 screw male connector	0,015	P8S-GPMHX
PNP type, normally open	3 m PVC-cable without connector	0,030	P8S-GPFLX
PNP type, normally open	10 m PVC-cable without connector	0,110	P8S-GPFTX
Reed sensors , 10-30 V AC/DC			
Normally open	0,27 m PUR-cable and 8 mm snap-in male connector	0,007	P8S-GSSHX
Normally open	0,27 m PUR-cable and M12 screw male connector	0,015	P8S-GSMHX
Normally open	3 m PVC-cable without connector	0,030	P8S-GSFLX
Normally open	10 m PVC-cable without connector	0,110	P8S-GSFTX
Normally closed	5m PVC-cable without connector ⁽¹⁾	0,050	P8S-GCFPX
Reed sensors, 10-120 V AC/DC			
Normally open	3 m PVC-cable without connector	0,030	P8S-GRFLX
Reed sensorer, 24-230 V AC/DC			
Normally open	3 m PVC-cable without connector	0,030	P8S-GRFLX2

1) Without LED

Connecting cables with one connector

The cables have an integral snap-in female connector.



Type of cable	Cable/connector	Weight kg	Order code
Cables for sensors, complete with one female connector			
Cable, Flex PVC	3 m, 8 mm Snap-in connector	0,07	9126344341
Cable, Flex PVC	10 m, 8 mm Snap-in connector	0,21	9126344342

The P1Q compact cylinder is ideal for applications where you need compact dimensions and high overall performance. The versatile P1Q cylinder range provides a long trouble-free operation in a variety of applications.



- Bore 12-100 mm with ISO 15524 conformity
- Compact and versatile
- Magnetic or non magnetic options
- Flush fit sensor range
- Buffer cushioning as standard
- Piston wear ring on Ø32 - Ø100mm
- Tapped both ends as standard

Operating information

Working pressure: Max 10 bar
 Permissible fluid: Air, with or without lubrication
 Standard working temperature: -5°C to +60°C

Prelubricated, further lubrication is not normally necessary. If additional lubrication is introduced it must be continued.

Double acting - Magnetic - Female threaded piston rod

Ø12mm

Stroke mm	Order code
5	P1QS012DC7G0005
10	P1QS012DC7G0010
15	P1QS012DC7G0015
20	P1QS012DC7G0020
25	P1QS012DC7G0025
30	P1QS012DC7G0030

Ø16mm

Stroke mm	Order code
5	P1QS016DC7G0005
10	P1QS016DC7G0010
15	P1QS016DC7G0015
20	P1QS016DC7G0020
25	P1QS016DC7G0025
30	P1QS016DC7G0030

Ø20mm

Stroke mm	Order code
10	P1QS020DC7G0010
15	P1QS020DC7G0015
20	P1QS020DC7G0020
25	P1QS020DC7G0025
30	P1QS020DC7G0030
40	P1QS020DC7G0040
50	P1QS020DC7G0050

Ø25mm

Stroke mm	Order code
10	P1QS025DC7G0010
15	P1QS025DC7G0015
20	P1QS025DC7G0020
25	P1QS025DC7G0025
30	P1QS025DC7G0030
40	P1QS025DC7G0040
50	P1QS025DC7G0050

Ø32mm

Stroke mm	Order code
10	P1QS032DC7G0010
15	P1QS032DC7G0015
20	P1QS032DC7G0020
25	P1QS032DC7G0025
30	P1QS032DC7G0030
40	P1QS032DC7G0040
50	P1QS032DC7G0050
75	P1QS032DC7G0075
100	P1QS032DC7G0100

Ø40mm

Stroke mm	Order code
15	P1QS040DC7G0015
20	P1QS040DC7G0020
25	P1QS040DC7G0025
30	P1QS040DC7G0030
40	P1QS040DC7G0040
50	P1QS040DC7G0050
75	P1QS040DC7G0075
100	P1QS040DC7G0100

Ø50mm

Stroke mm	Order code
15	P1QS050DC7G0015
20	P1QS050DC7G0020
25	P1QS050DC7G0025
30	P1QS050DC7G0030
40	P1QS050DC7G0040
50	P1QS050DC7G0050
75	P1QS050DC7G0075
100	P1QS050DC7G0100

Ø63mm

Stroke mm	Order code
15	P1QS063DC7G0015
20	P1QS063DC7G0020
25	P1QS063DC7G0025
30	P1QS063DC7G0030
40	P1QS063DC7G0040
50	P1QS063DC7G0050
75	P1QS063DC7G0075

Ø80mm

Stroke mm	Order code
15	P1QS080DC7G0015
20	P1QS080DC7G0020
25	P1QS080DC7G0025
30	P1QS080DC7G0030
40	P1QS080DC7G0040
50	P1QS080DC7G0050
75	P1QS080DC7G0075

Ø100mm

Stroke mm	Order code
15	P1QS100DC7G0015
20	P1QS100DC7G0020
25	P1QS100DC7G0025
30	P1QS100DC7G0030
40	P1QS100DC7G0040
50	P1QS100DC7G0050
75	P1QS100DC7G0075

Double acting - Non-magnetic - Female threaded piston rod

Ø 12 mm

Stroke mm	Order code
5	P1QS012DC7B0005
10	P1QS012DC7B0010
15	P1QS012DC7B0015
20	P1QS012DC7B0020
25	P1QS012DC7B0025
30	P1QS012DC7B0030

Ø 16 mm

Stroke mm	Order code
5	P1QS016DC7B0005
10	P1QS016DC7B0010
15	P1QS016DC7B0015
20	P1QS016DC7B0020
25	P1QS016DC7B0025
30	P1QS016DC7B0030

Ø 20 mm

Stroke mm	Order code
10	P1QS020DC7B0010
15	P1QS020DC7B0015
20	P1QS020DC7B0020
25	P1QS020DC7B0025
30	P1QS020DC7B0030
40	P1QS020DC7B0040
50	P1QS020DC7B0050

Ø 25 mm

Stroke mm	Order code
10	P1QS025DC7B0010
15	P1QS025DC7B0015
20	P1QS025DC7B0020
25	P1QS025DC7B0025
30	P1QS025DC7B0030
40	P1QS025DC7B0040
50	P1QS025DC7B0050

Ø 32 mm

Stroke mm	Order code
10	P1QS032DC7B0010
15	P1QS032DC7B0015
20	P1QS032DC7B0020
25	P1QS032DC7B0025
30	P1QS032DC7B0030
40	P1QS032DC7B0040
50	P1QS032DC7B0050
75	P1QS032DC7B0075
100	P1QS032DC7B0100

Ø 40 mm

Stroke mm	Order code
15	P1QS040DC7B0015
20	P1QS040DC7B0020
25	P1QS040DC7B0025
30	P1QS040DC7B0030
40	P1QS040DC7B0040
50	P1QS040DC7B0050
75	P1QS040DC7B0075
100	P1QS040DC7B0100

Ø 50 mm

Stroke mm	Order code
15	P1QS050DC7B0015
20	P1QS050DC7B0020
25	P1QS050DC7B0025
30	P1QS050DC7B0030
40	P1QS050DC7B0040
50	P1QS050DC7B0050
75	P1QS050DC7B0075
100	P1QS050DC7B0100

Ø 63 mm

Stroke mm	Order code
15	P1QS063DC7B0015
20	P1QS063DC7B0020
25	P1QS063DC7B0025
30	P1QS063DC7B0030
40	P1QS063DC7B0040
50	P1QS063DC7B0050
75	P1QS063DC7B0075

Ø 80 mm

Stroke mm	Order code
15	P1QS080DC7B0015
20	P1QS080DC7B0020
25	P1QS080DC7B0025
30	P1QS080DC7B0030
40	P1QS080DC7B0040
50	P1QS080DC7B0050
75	P1QS080DC7B0075

Ø 100 mm

Stroke mm	Order code
15	P1QS100DC7B0015
20	P1QS100DC7B0020
25	P1QS100DC7B0025
30	P1QS100DC7B0030
40	P1QS100DC7B0040
50	P1QS100DC7B0050
75	P1QS100DC7B0075

Mountings

Flange

	Cyl. Ø mm	Order code
	12	P1Q-4DMB
	16	P1Q-4FMB
	20	P1Q-4HMB
	25	P1Q-4JMB
	32	P1Q-4KMB
	40	P1Q-4LMB
	50	P1Q-4MMB
	63	P1Q-4NMB
	80	P1Q-4PMB
100	P1Q-4QMB	

Foot bracket

	Cyl. Ø mm	Order code
	12	P1Q-4DMF
	16	P1Q-4FMF
	20	P1Q-4HMF
	25	P1Q-4JMF
	32	P1Q-4KMF
	40	P1Q-4LMF
	50	P1Q-4MMF
	63	P1Q-4NMF
	80	P1Q-4PMF
100	P1Q-4QMF	

Clevis mounting

	Cyl. Ø mm	Order code
	12	P1Q-4DMT
	16	P1Q-4FMT
	20	P1Q-4HMT
	25	P1Q-4JMT
	32	P1Q-4KMT
	40	P1Q-4LMT
	50	P1Q-4MMT
	63	P1Q-4NMT
	80	P1Q-4PMT
100	P1Q-4QMT	

Electronic and Reed Sensors

Size	Description	Order code
PNP Type, normally open	0.165 m cable and M8 screw male connector	P8S-EPSUS
PNP Type, normally open	2 m PUR cable without connector	P8S-EPFXS
NPN Type, normally open	0.165 m cable and M8 screw male connector	P8S-ENSUS
NPN Type, normally open	2 m PUR cable without connector	P8S-ENFXS
Reed Type, normally open	0.15 m cable and M8 screw male connector	P8S-ERSUS
Reed Type, normally open	2 m PUR cable without connector	P8S-ERFXS

Origa System Plus - Innovation from a proven design

A completely new generation of linear drives which can be simply and neatly integrated into any machine layout.

A NEW MODULAR LINEAR DRIVE SYSTEM

With this second generation linear drive Parker Origa offers design engineers complete flexibility. The well known ORIGA cylinder has been further developed into a combined linear actuator, guidance and control package. It forms the basis for the new, versatile ORIGA SYSTEM PLUS linear drive system.

All additional functions are designed into modular system components which replace the previous series of cylinders.

MOUNTING RAILS ON 3 SIDES

Mounting rails on 3 sides of the cylinder enable modular components such as linear guides, brakes, valves, magnetic switches etc. to be fitted to the cylinder itself. This solves many installation problems, especially where space is limited.

The modular system concept forms an ideal basis for additional customer-specific functions.

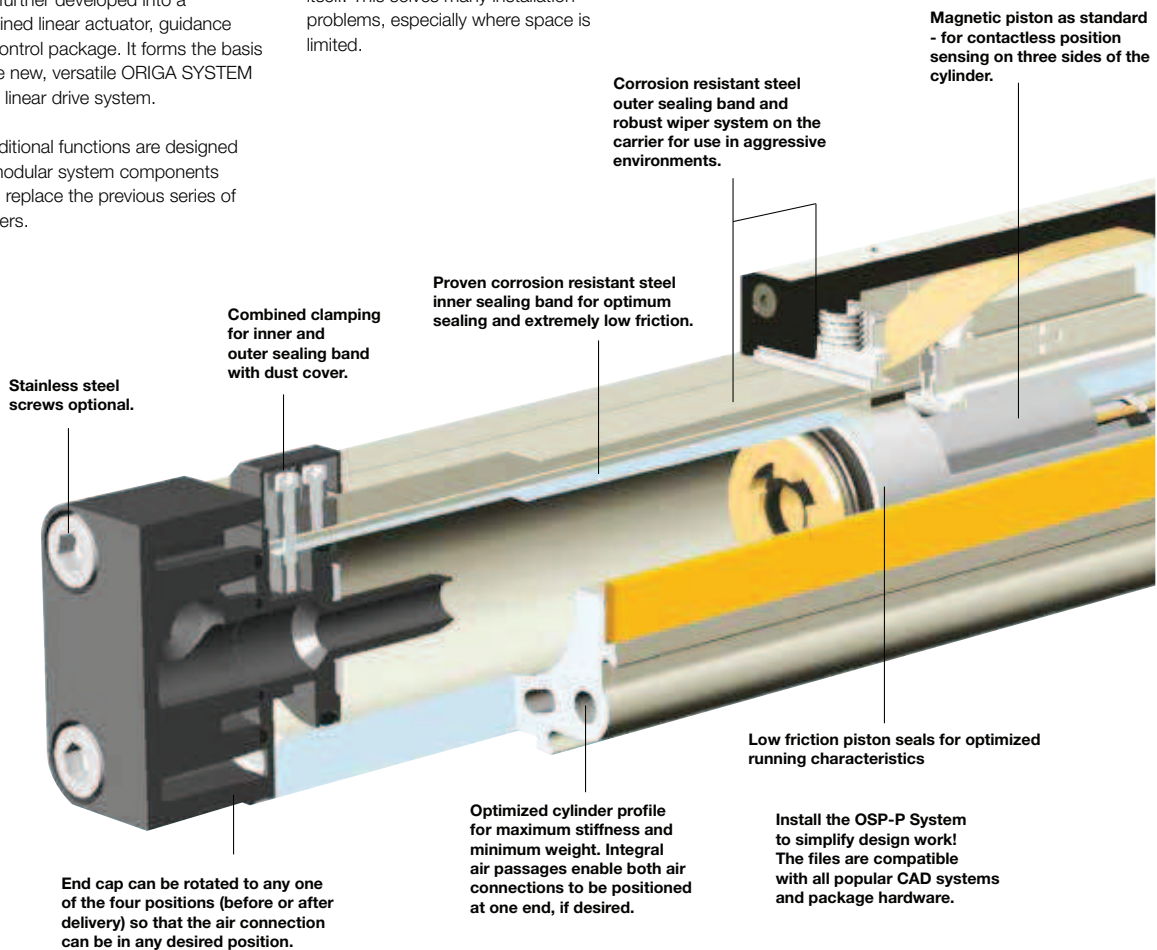

Clean Room Version
certified to DIN EN ISO 14644-1



Rodless Cylinder
for synchronized bi-parting movements

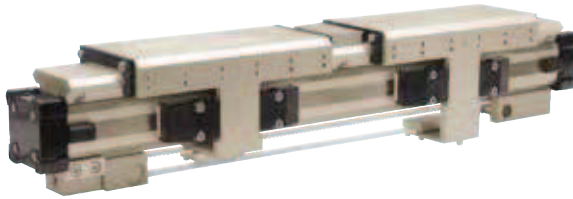

New low profile
piston/carrier design.

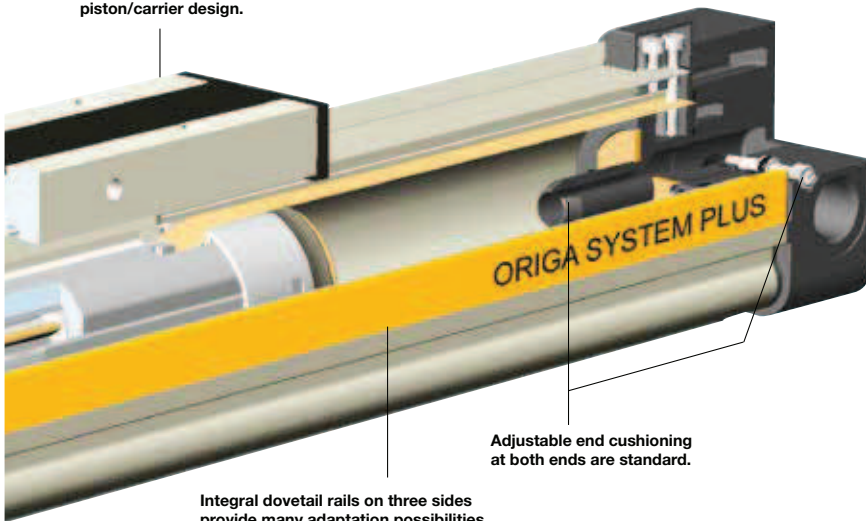

Adjustable end cushioning
at both ends are standard.

Integral dovetail rails on three sides
provide many adaptation possibilities
(linear guides, magnetic switches,
etc.).

Modular system components
are simply clamped on.

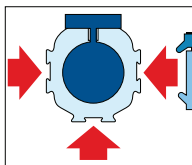

**INTEGRATED
VOE VALVES**
The complete
compact solution
for optimal cylinder
control.

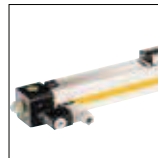

SENSOFLEX
SFI-plus
incremental
measuring system
with 0,1 (1,0) mm
resolution.



BASIC GUIDE
Compact, robust
plain bearing
guide for medium
loads.



SLIDELINE
Guide system for
moderate loads.
Optional with
Active- / Passive-
Brake



POWERSLIDE
Roller guide for
high loads and
rough conditions



PROLINE
The compact
aluminium roller
guide for high loads
and velocities.
Optional with
Active- / Passive-
Brake.



STARLINE
Recirculating ball
bearing guide for
very high loads
and precision.



KF GUIDE
Recirculating ball
bearing guide
– the mounting
dimensions
correspond to
FESTO Type:
DGPL-KF



**HEAVY DUTY
GUIDE HD**
for heavy duty
applications.



**VARIABLE STOP
VS**
The variable stop
provides simple
stroke limitation.



PASSIVE BRAKE
reacts automatically
to pressure failure.

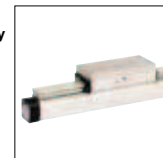

ACTIVE BRAKE
pneumatic brake
for secure, positive
stopping at any
position.

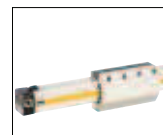

For more information see - Parker Pneumatic Catalogue PDE2600PNUK

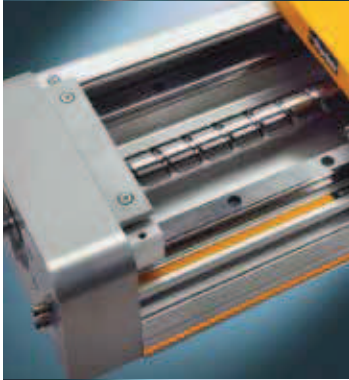

ORIGA HMR

High Moment Rodless Electric Linear Actuator - Three Drive Technologies: Screw, Toothed Belt, Linear Motor

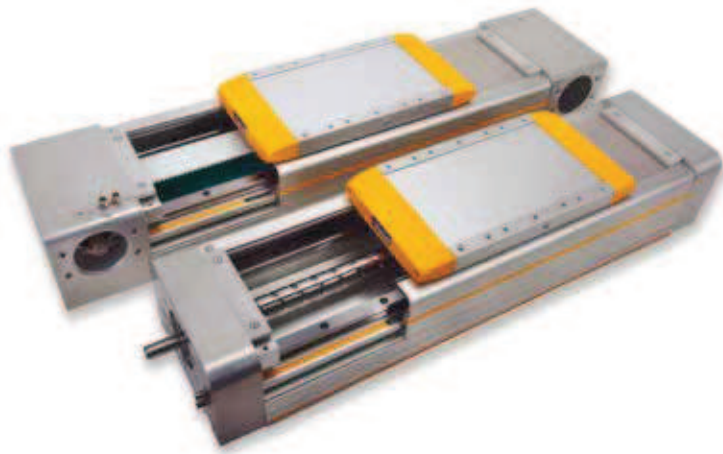

Linear Drive

Driving the future

The HMR linear drive system can be equipped with a “basic” or “reinforced” profile as standard. The “basic” profile is suitable for fitting directly to a machine base that has a corresponding support surface. The “reinforced” profile, on the other hand, is the preferred choice for self-supporting systems or for use in conjunction with a base surface offering limited support.

- Three alternative drive technologies in one profile
- Unique flexibility and reliability
- High speed and precision
- Two profile versions, four profile sizes
- Optional IP54 snap-in covers

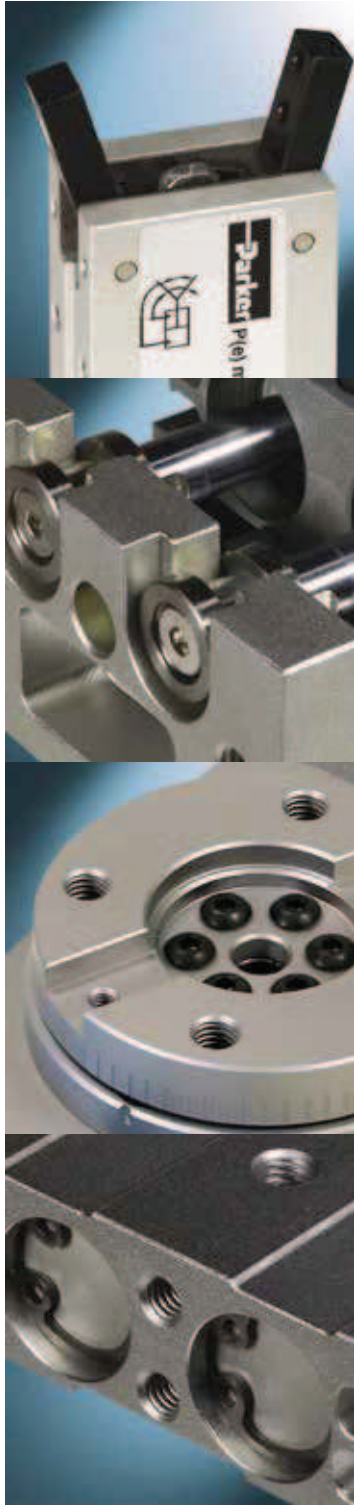

Handling Products

Comprising an innovative range of Grippers, Rotary Tables and Slide Tables



Parker is about motion control engineering, manufacturing, application expertise and unparalleled customer service.

Parker products are everywhere — from laboratories, cleanrooms and factory floors, to mines, foundries and satellites in space — our products are used anywhere machines, processes and people depend on reliable high-performance motion control.

Today's industrial handling applications demand the best in quality and productivity. Likewise, high-technology applications demand performance in quality throughput and precision.